

Connectors

Valves and filters

Manifolds

Pressure gauges

Cylinders, tubes

Quick release couplings

Instrument enclosures

# Instrumentation



## Connectors:

### LET-LOK® connectors



LET-LOK® tubes connectors are designed to work at high pressure, vacuum, high temperatures, vibrations and where excellent leak tightness of connection is required.

The connectors are available as couplings (to connect several tubes) and connectors (to join tubes with fittings) with male or female thread.

### Features and benefits of LET-LOK® connectors

- ✔ Suit a range of tube diameters, from 2 mm up to 50 mm and from 1/16" up to 2"
- ✔ Maximum working pressure: up to 820 bar
- ✔ Working temperature: up to +648°C
- ✔ Excellent tightness of connection even after repeated assembly and disassembly
- ✔ Long service life, the connectors can be disassembled and reassembled up to 20 times
- ✔ Very good leak tightness in high pressure and temperature conditions, vacuum, vibrations and during pressure surges
- ✔ Many material versions available: AISI 316 acid resistant steel, brass, alloys such as Monel 400, Hastelloy C-276, Super Duplex, 6Mo and carbon steel on request
- ✔ Back ring is additionally hardened by low temperature carburisation. This kind of treatment enhances surface hardness with no impact on corrosion resistance
- ✔ Male threads of LET-LOK® connectors are shaped in a rolling process to increase their fatigue strength and resistance to frictional wear
- ✔ Body, rings and nuts are made of barstocks or forgings
- ✔ Each element of the connector is marked with information helping to identify it, e.g. with a heat number to trace the element back to the material batch it was made of

### Construction of LET-LOK® connector

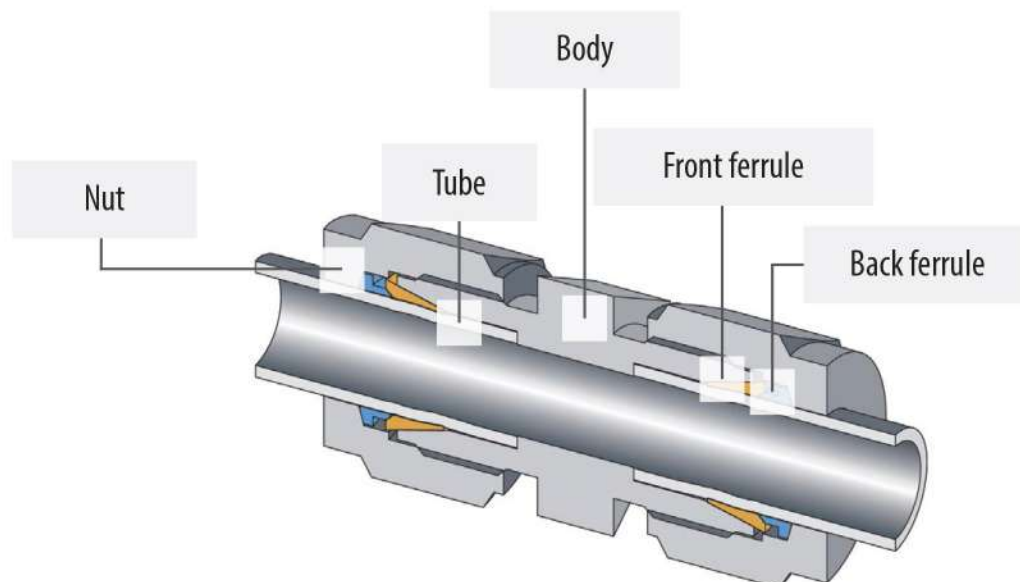

## Connectors:

### Other connectors



#### Threaded connectors

- ✓ NPT thread connectors from 1/16" to 2" and reducing connectors: NPT to BSP or BSPT
- ✓ Materials: AISI 316 stainless steel, brass, Monel 400, Hastelloy C-276, Super Duplex and 6Mo
- ✓ Working pressure: up to 759 bar, depends on size and temperature



#### HTC connectors

- ✓ Special type of connectors designed for high purity applications, for example in the semiconductor industry
- ✓ All connectors are made of AISI 316L steel and processed by electropolishing



#### Connectors for orbital welding

- ✓ Connectors made of AISI 316L steel, designed for orbital welding
- ✓ Both inch and metric size connectors are available as straight connectors, elbows, tees and with one threaded end



#### SAE 37° JIC connectors

- ✓ Special type of connectors intended for inch and metric tubes with ends flared at a 37° angle



#### Flange connectors

- ✓ LET-LOK® connectors with flanges according to EN, ANSI, JIS standards
- ✓ Made of (one element): AISI 316 steel, Monel 400 and Hastelloy C-276
- ✓ Made of AISI 316 steel, also as a welded connector

## Valves:

### Ball valves



Precision ball valves are used in control and measuring equipment for the chemical, petrochemical, pharmaceutical and power industries, nuclear power plants and process engineering.

Available in many different versions depending on working temperature, pressure and type of connection. All valves can be supplied in Oxygen Clean version. Optionally, each valve can be equipped with a single-acting or double-acting pneumatic actuator, also ATEX compliant.

#### H-6800

<b>Valve material:</b>	AISI 316 steel or brass
<b>Ball material:</b>	AISI 316 steel or brass
<b>Sealing:</b>	modified PTFE – from -34°C to +210°C PCTFE – from -40°C to +140°C PEEK – from -34°C to +260°C
<b>Working pressure:</b>	modified PTFE – up to 206 bar PCTFE, PEEK – up to 410 bar
<b>Connections:</b>	LET-LOK®, NPT, BSPT and BSP threads

- ① All sizes and diameters can be ordered as special patent construction, ECE R110 approved for CNG application.



#### H-800

<b>Valve material:</b>	AISI 316 steel
<b>Ball material:</b>	AISI 316 steel
<b>Sealing:</b>	PFA – from -54°C to +150°C
<b>Working pressure:</b>	up to 206 bar
<b>Connections:</b>	LET-LOK®, NPT, BSPT and BSP threads



#### H-700

<b>Valve material:</b>	AISI 316 steel
<b>Ball material:</b>	AISI 316 steel
<b>Sealing:</b>	modified PTFE – from -42°C to +204°C
<b>Working pressure:</b>	up to 135 bar
<b>Connections:</b>	LET-LOK®, NPT, BSPT and BSP threads



#### H-500

<b>Valve material:</b>	AISI 316 steel
<b>Ball material:</b>	AISI 316 steel
<b>Sealing:</b>	PTFE – from -28°C to +186°C modified PTFE – from -28°C to +204°C UPE – from -28°C to +122°C SS PTFE – from -28°C to +232°C PEEK – from -28°C to +232°C
<b>Working pressure:</b>	up to 206 bar
<b>Connections:</b>	LET-LOK®, NPT, BSPT and BSP threads, weld ends



## Valves:

### Needle valves



Precision needle valves, depending on their construction, are used as shut-off valves to control the flow and for dosing media. There are 4 types of stems:

- A – regulating
- B – standard V-type, on/off valve operation
- C – with a non-rotating stem, reduces friction, suitable for high pressure gases and large number of cycles
- D – with a non-rotating stem, with soft replaceable sealing, ensures lower torque while tightening, suitable for high pressure high purity gases

Available in many different versions, depending on working temperature, pressure and type of connection. All needle valves can be supplied in Oxygen Clean version.

#### H-99

<b>Valve material:</b>	AISI 316 steel
<b>Stem material:</b>	AISI 316 steel
<b>Valve sealing:</b>	metal / metal
<b>Gland packing:</b>	PTFE – from -40°C to +204°C PEEK – from -40°C to +260°C Grafoil from -40°C to +648°C
<b>Working pressure:</b>	up to 690 bar
<b>Connections:</b>	LET-LOK®, NPT, BSPT and BSP threads, weld ends



#### H-300

<b>Valve material:</b>	AISI 316 steel / brass
<b>Stem material:</b>	AISI 316 steel
<b>Valve sealing:</b>	metal / metal – from -51°C to +230°C PCTFE – from -46°C to +93°C
<b>Gland packing:</b>	PTFE
<b>Working pressure:</b>	up to 345 bar
<b>Connections:</b>	LET-LOK®, HTC, NPT, BSPT and BSP threads



## Valves:

### Check valves

Precision check valves are designed to allow the flow of a medium only in one direction. The check valve opens at so-called opening pressure i.e. pressure difference (pressure rise) between the inlet and the outlet of the valve. Similarly: when the pressure at the inlet of the valve drops below the set level value, the valve closes.

#### H-400

<b>Valve material:</b>	AISI 316 steel / brass
<b>Valve sealing:</b>	Viton – from -23°C to +190°C EPDM – from -45°C to +148°C NBR – from -23°C to +121°C CR – from -40°C to +121°C Kalrez – from -26°C to +260°C
<b>Working pressure:</b>	up to 413 bar
<b>Connections:</b>	LET-LOK®, NPT, BSPT and BSP threads



## Valves: Metering valves



Precision metering valves for general purpose application, also suitable for panel mounting. 3 valve versions are available depending on required working pressure, flow rate and accuracy. Can be supplied as straight or angle valve. Several handle options, also a Vernier handle to facilitate easier valve opening control. This range of valves includes a unique, patent version with an integrated ball valve to allow both full flow control and complete shut-off at the same time.

### H-1300

<b>Valve material:</b>	AISI 316 steel / brass
<b>Valve sealing:</b>	metal / metal
<b>Gland packing:</b>	Viton – from -26°C to +204°C EPDM – from -23°C to +149°C NBR – from -23°C to +149°C CR – from -23°C to +121°C Kalrez – from -18°C to +149°C
<b>Working pressure:</b>	up to 138 bar
<b>Connections:</b>	LET-LOK®, NPT, BSPT and BSP threads



### MBV (ball valve - metering)

<b>Valve material:</b>	AISI 316 steel
<b>Sealing of a dosing valve:</b>	Viton
<b>Sealing of a ball valve:</b>	AISI 316 + PFA
<b>Working pressure:</b>	up to 137 bar
<b>Working temperature:</b>	from -26°C to +149°C
<b>Connections:</b>	LET-LOK®, NPT, BSPT and BSP threads



## Valves: Relief/safety valves

Precision, general purpose relief valves made of AISI 316 stainless steel. 8 versions depending on required opening pressure. Each pressure version is marked differently (from A to H), colour of the spring and label on the valve allow identification of the opening pressure range.

### H-900HP

<b>Valve material:</b>	AISI 316 steel
<b>Valve sealing:</b>	Viton – from -12°C to +121°C EPDM – from -1°C to +121°C NBR – from -23°C to +121°C CR – from -34°C to +148°C
<b>Working pressure:</b>	up to 413 bar
<b>Connections:</b>	LET-LOK®, NPT, BSPT and BSP threads



## Valves:

### UCV valves



UCV – Ultra Clean Valves, special type of diaphragm valves designed for high purity applications, for example in the semiconductor industry. Available as manual valves or with a pneumatic actuator.

#### UCV – Ultra Clean Valves

<b>Valve material:</b>	AISI 316L steel
<b>Sealing material:</b>	PCTFE
<b>Diaphragm material:</b>	Co-Cr-Ni alloy (Elgiloy)
<b>Working pressure:</b>	up to 210 bar
<b>Connections:</b>	LET-LOK®, HTC, weld end

- ❶ Special type of valves designed for high purity applications e.g. for the semiconductor industry.



## Filters:

### Filters

Precision filters protect system components against contaminants in the medium flowing through. Two filter versions: in-line and T-type.

- ❶ All sizes and diameters of T-type can be ordered as special patent construction, ECE R110 approved for CNG application.

#### H-600

<b>Valve material:</b>	AISI 316 steel / brass
<b>Working pressure:</b>	up to 206 bar
<b>Working temperature:</b>	from -28°C to +482°C
<b>Degree of filtration:</b>	from 0.1µm to 440µm
<b>Connections:</b>	LET-LOK®, NPT, BSPT and BSP threads

#### H-600R

<b>Valve material:</b>	AISI 316 steel / brass
<b>Working pressure:</b>	up to 413 bar
<b>Working temperature:</b>	from -37°C to +482°C
<b>Degree of filtration:</b>	from 0.1µm to 440µm
<b>Connections:</b>	LET-LOK®, NPT, BSPT and BSP threads



# Manifolds

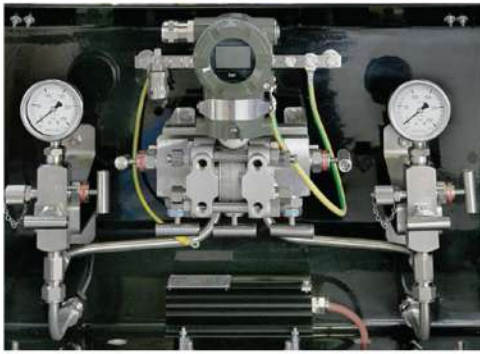

## Features and benefits of manifolds

- ✓ All manifolds conform to NACE MR-01-75 standard (this standard includes criteria for material selection and specifications of materials resistant to sulphide stress cracking, which are used when equipment comes into contact with H<sub>2</sub>S)
- ✓ Ceramic ball in the stem for increased valve service life
- ✓ Stem is made of AISI 316Ti steel with chromium carbide coating
- ✓ Wide scope of sealing options: PTFE, Grafoil, FKM, NBR, EPDM and Kalrez
- ✓ All manifolds are factory tested
- ✓ Working pressure: up to 690 bar
- ✓ Working temperature: from -60°C to +550°C, depending on sealing
- ✓ Connection types:
  - a) direct mount to a transmitter (thread-flange connection)
  - b) remote mount, joined by tubes – thread connections (or LET-LOK<sup>®</sup> compression connectors)
- ✓ Connecting flanges made according to IEC 61518 / DIN 19213 standard
- ✓ Available material versions: AISI 316 steel, Monel 400, Hastelloy C-276, Duplex 1.4462, Super Duplex, Tytan, 6Mo

The valves are colour-coded to allow easy function identification:

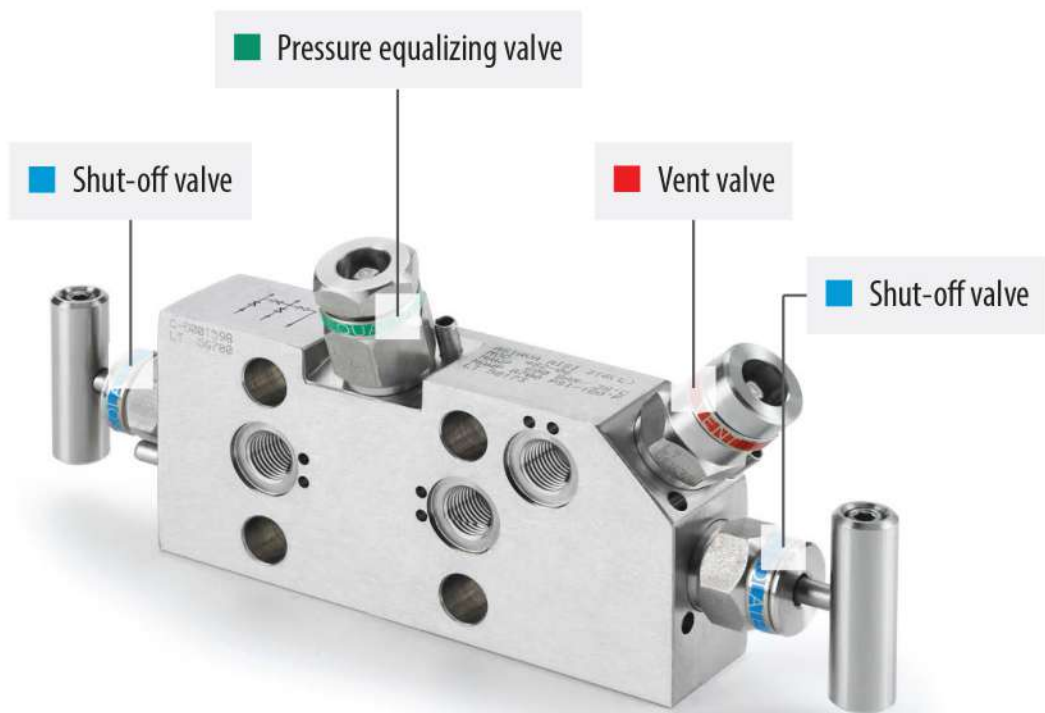

**Red colour: Vent valve**  
Designed to release the pressure from the manifold.

**Blue colour: Shut-off valve**  
Used to close and open the valve.

**Green colour: Pressure equalizing valve**  
Applied starting from 3-way manifolds and used to equalize the pressure between the valve outlets.



# Manifolds

**i** Other types available on request.

## Needle valves - basic configurations

Female thread at both ends 



**M-10S**

3-way, male thread / female thread 



**M-11-S**

3-way, long male thread / female thread 



**M-11-S-L**

Male thread / female thread with vent 



**M-12-M**

## 2-way manifold - basic configurations

Female thread / IEC 61518 flange 



**M-20S**

IEC 61518 flange at both ends 



**M-20H**

Female thread at both ends 



**M-20M**

Female thread at both ends 



**M-21A**

Female thread at both ends 



**M-21S**

# Manifolds

**i** Other types available on request.

## 3-way manifold - basic configurations

Female thread  
/ IEC 61518 flange

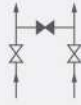

M-30H



IEC 61518 flange  
at both ends

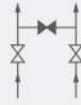

M-30H



Female thread  
/ IEC 61518 flange

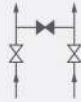

M-30I



Female thread  
/ IEC 61518 flange

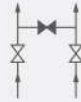

M-30A



Female thread  
at both ends

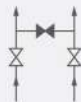

M-30S



Female thread  
at both ends



M-32M



# Manifolds

**i** Other types available on request.

## 5-way manifold - basic configurations

Female thread  
/ IEC 61518 flange

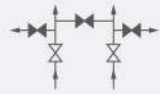

M-50A



Female thread  
/ IEC 61518 flange



M-53T



IEC 61518 flange  
at both ends

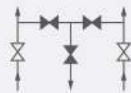

M-54H



Female thread  
at both ends

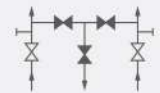

M-53S



Female thread  
at both ends

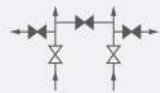

M-50A



## Pressure gauges



HAM-LET industrial pressure gauges made of stainless steel according to EN 837 and ASME B40.1 standards, highly reliable in all conditions.

Measuring range can be selected in accordance with working pressure and pressure gauge diameter so that:

Operating mode	Dial diameter 100mm, 115mm and 160mm		Dial diameter 40mm, 50mm and 63mm	
	Maximum allowable pressure		Maximum allowable pressure	
<b>Constant pressure:</b>	100%		75%	
<b>Pulsating pressure:</b>	90%		65%	
<b>Pressure impulse:</b>	130%		100%	

The pressure gauges are designed to withstand a temporary pressure up to 300% of their measuring range without failure. Optionally, there is also a version of low pressure gauges designed to withstand a pressure impulse up to 1000% of measuring range.

### Features and benefits of pressure gauges

- ✔ Case diameter: 40 mm, 50 mm, 63 mm, 100 mm, 115 mm and 160 mm
- ✔ Measuring range: from -1 bar up to 1600 bar
- ✔ Manufactured in accuracy class: 0.5, 1, 1.6, 2.5
- ✔ Made in compliance with EN 837 and ASME B40.1 standard
- ✔ Wet parts made of AISI 316L acid resistant steel (optionally Monel 400)
- ✔ Filling: glycerine, dry silicone oil
- ✔ Bottom, back, centre back connections and for panel mounting
- ✔ Connections: BSP, NPT and metric threads, pipe stub, HTC connection, 9/16" HP thread
- ✔ Available as ATEX compliant version



### Connection examples



# Sample cylinders, tubes



## Cylinders

- ✓ Made of stainless steel according to ASTM A269
- ✓ Used to extract samples, to store them and transport safely to a laboratory for analysis
- ✓ Standard volume from 50 cm<sup>3</sup> up to 500 cm<sup>3</sup> (bigger volumes available on request)
- ✓ Standard working pressure 124 bar (1800 psi) (higher pressure on request)



## Needle valve with a rupture disc

- ✓ Needle valve with a rupture disc is designed to be mounted on sample cylinders
- ✓ Rupture disc protects the cylinder against over pressure. When the pressure exceeds the maximum value, the disc bursts venting the medium to the atmosphere

H-285

<b>Valve material:</b>	AISI 316 steel
<b>Stem material:</b>	AISI 316 steel
<b>Sealing:</b>	PEEK
<b>Working temperature:</b>	up to +122°C
<b>Working pressure:</b>	up to 206 bar
<b>Disc burst pressure:</b>	131 bar or 196 bar



## Tubes

- ✓ AISI 316L (1.4435) stainless steel precision seamless tubes intended for LET-LOK<sup>®</sup> connectors
- ✓ Compliant with many standards including ASTM A 213-AW, PED 97/23/E and NACE MR0175
- ✓ Available in sections up to 6m, both metric and imperial sizes
- ✓ Coiled tube available on request. Standard coil length 300-350 m, longer sections joined using orbital welding

## QC-LOK quick release couplings



Single shut-off or double shut-off precision quick release couplings made of AISI 316 stainless steel. Used in numerous applications including: aviation, gas industry, medical and pharmaceutical industry, laboratories.

Available in three sizes: QC4, QC6 and QC8. All quick release couplings are factory tested for tightness. Interchangeable with Instrumentation standard quick release couplings of other manufacturers.

### Sealing options

Viton (from -26°C up to +204°C) – standard  
 NBR (from -37°C up to +121°C)  
 EPDM (from -57°C up to +121°C)  
 CR (from -37°C up to +107°C)  
 Kalrez (from -26°C up to +260°C)

### Working pressure

QC4 – 206 bar  
 QC6 – 103 bar  
 QC8 – 51.7 bar

### Available connections

NPT thread  
 BSP thread  
 BSPT thread  
 LET-LOK® connection

### Flow rates

QC4 – 15 l/min  
 QC6 – 22 l/min  
 QC8 – 37 l/min

### Basic information on QC-LOK quick release couplings

- ✓ All quick release couplings are factory tested to check for tightness (not selectively)
- ✓ AISI 316 stainless steel
- ✓ Single or double shut-off
- ✓ Interchangeable with Instrumentation standard quick release couplings of other manufacturers



## Instrument enclosures



Tubes International provides instrument enclosures (instrumentation enclosures) in an array of sizes, also as fully fitted units with instrumentation selected according to the Customer specifications.

They are designed to protect control and measurement equipment against rain, sunlight, dust and mechanical damage. Antistatic enclosures are compliant with EN 50014 standard and fire retardant enclosures are compliant with DIN 4102 Class B2.

Example below - enclosure fitted with instrumentation:

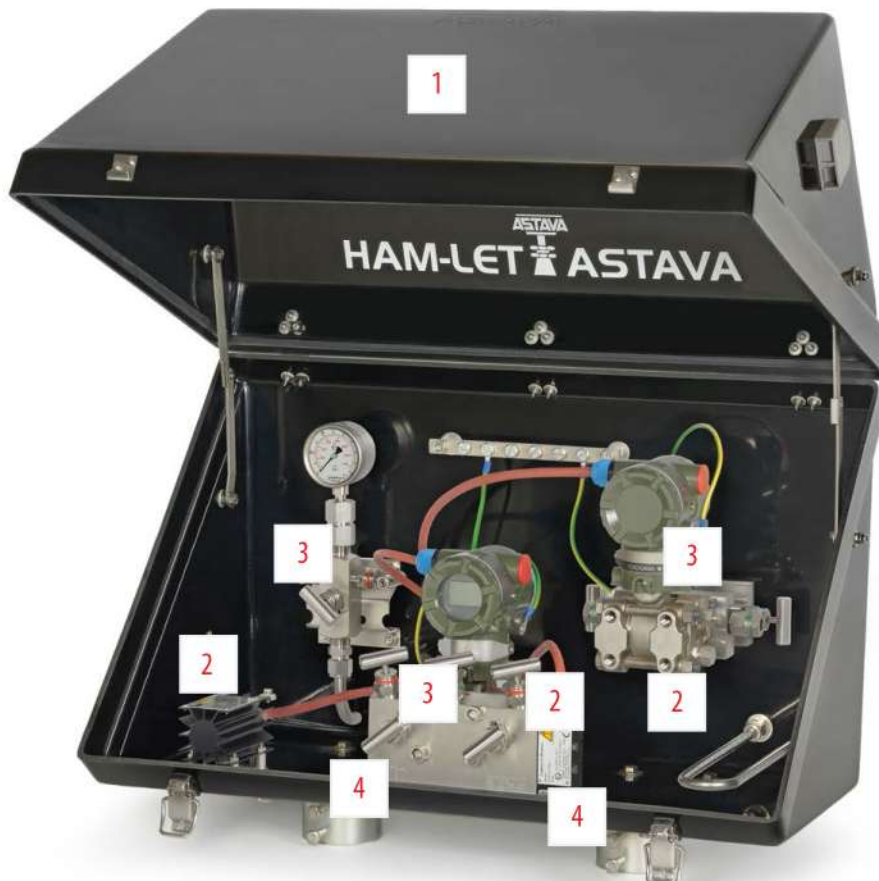

### 1 Antistatic, flame retardant enclosure IP65

- Housing made of glass fibre reinforced polyester resin, as a shade or enclosure
- Full AISI 316 stainless steel housing

### 2 Heating element

- Steam heater
- Electric heater (black anodised aluminium, AISI 316 stainless steel)
- Thermostat

### 3 Manifold according to Customer's specification

### 4 Connections according to Customer's specification